

KROS Reguleerklapp

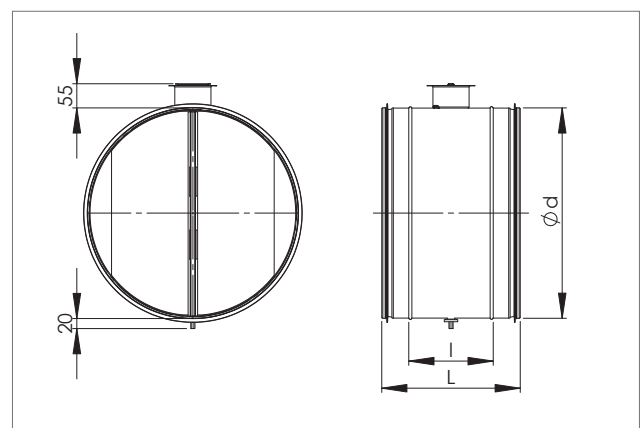
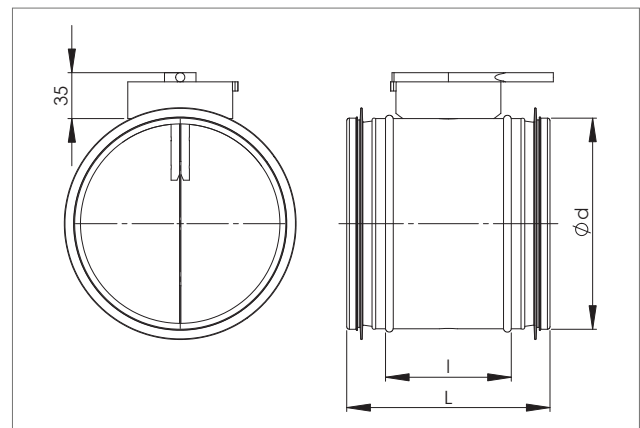

KROS reguleerklapp on ette nähtud õhuhulkade reguleerimiseks ventilatsioonitorustikes.

- Lihtne paigaldada
- Klapi korpus on varustatud otstesse valtsitud kummitihenditega
- Korpuse tihedusklass C

Konstruksioon ja mõõdud

KROS-reguleerklapi korpus ja laba on valmistatud kuumtsingitud teraslehest. Reguleerklapp on varustatud otstest kummitihenditega. Puksid on polüamiidist (max +150°C).

Nimimõõt, d mm	l, mm	lp, mm	L, mm	Kaal, kg
80	95	29	155	0,29
100	95	29	155	0,35
125	95	29	155	0,45
160	95	29	155	0,6
200	95	29	155	0,75
250	95	50	215	1,4
315	95	50	215	1,9
400	95	50	215	3,1
500	125	65	255	4,4
630	125	65	255	6,0

Tehnilised andmed

4

NORDdamper | KROS

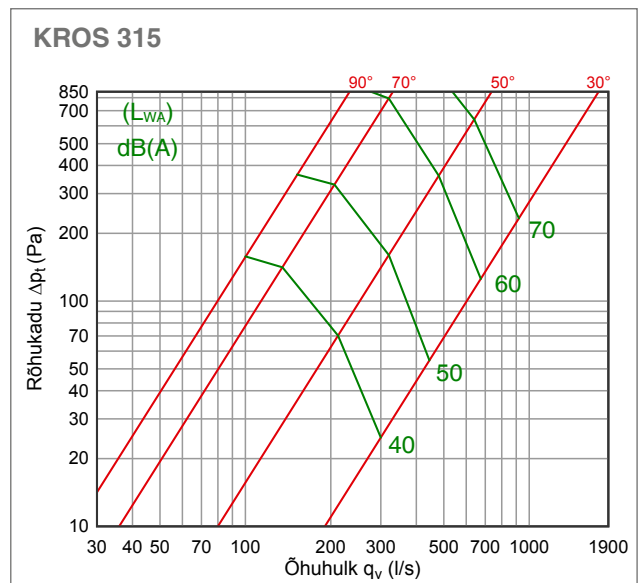
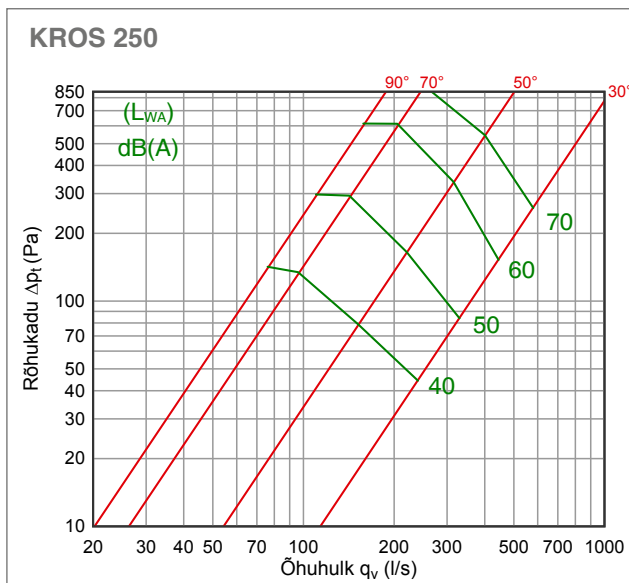
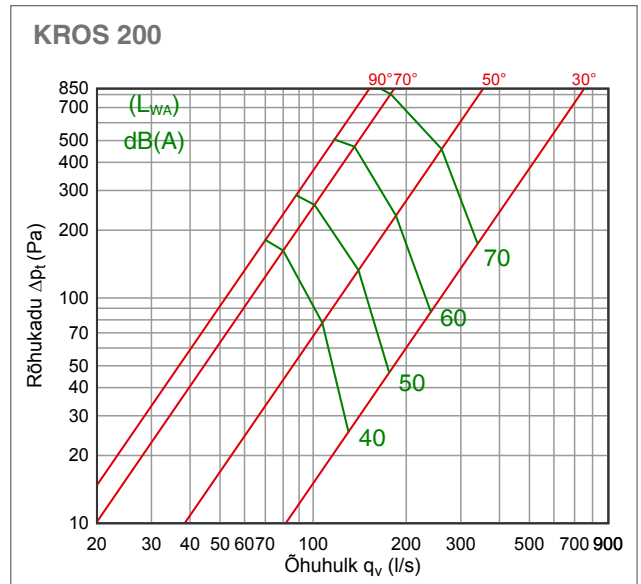
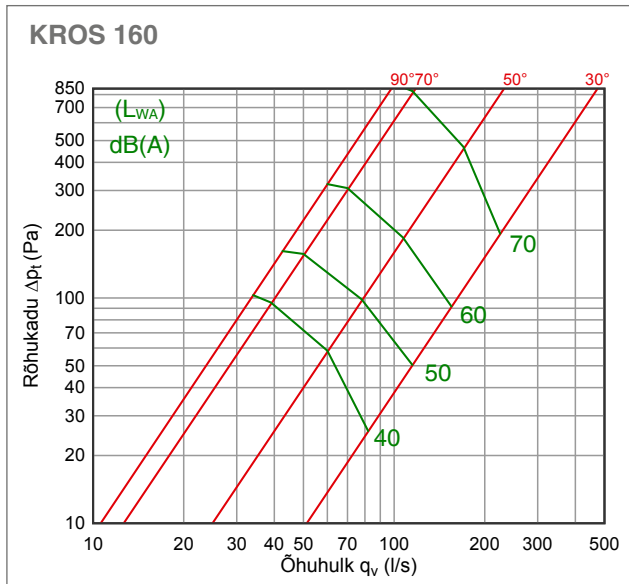
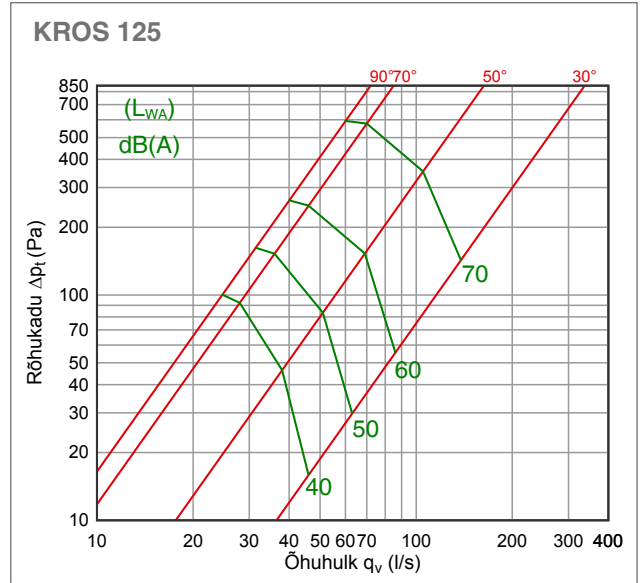
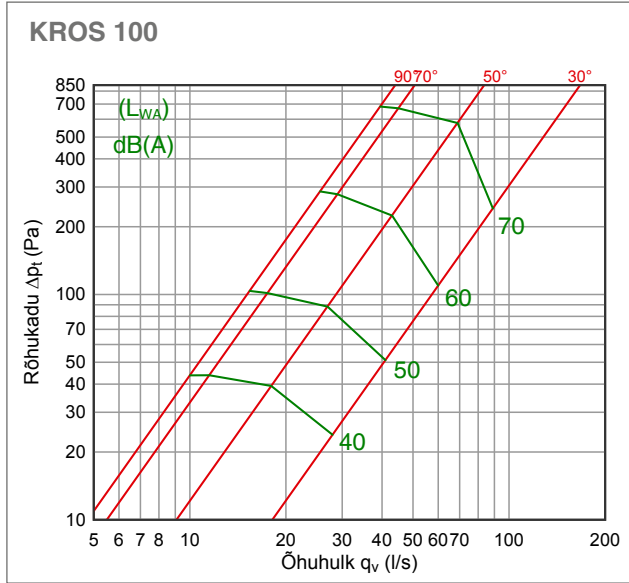

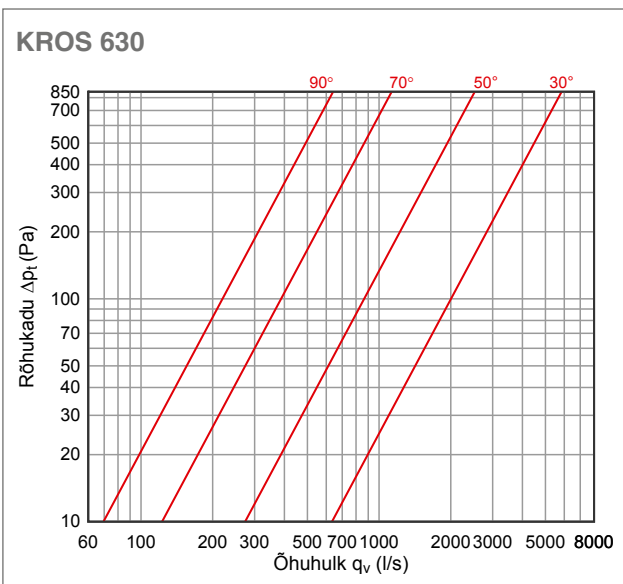
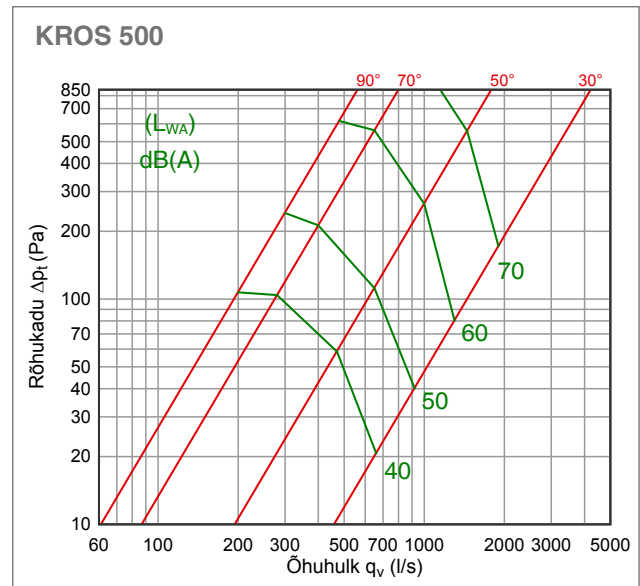
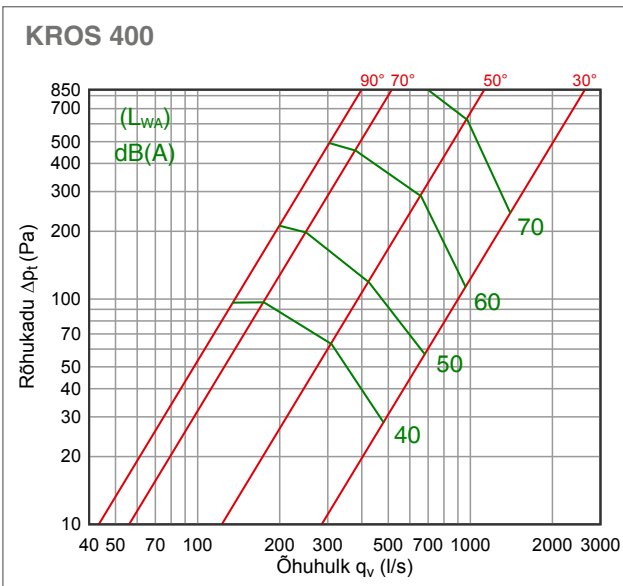

Markeerimine

KROS	Ød
Tähis	Läbimõõt

Näide: KROS 315

Paigaldus

Klapp ühendatakse kanaliga ja kinnitatakse neetide abil (vt. NORDduct paigaldusjuhendit).